

-80 to 300°C

Stirred Liquid Baths

Orion 796

- Can accept large Water Triple Point Cells
- Variable Cooling Power
- Low Filling Cost

The Isotech Hydra range of calibration baths have proved very successful since their introduction in 2003. The Orion range has been introduced to fit alongside the Hydra models.

The Orion calibration baths offer deeper calibration volumes than the Isotech Hydra series with world class temperature stability. There is a high temperature model (30°C to 300°C) and two models with built in refrigeration (-40°C to 125°C) and (-80°C to 125°C).

These deep stirred liquid baths are suitable for the low uncertainty calibration of long thermometers including liquid in glass and extended length SPRTS.

The Orion unit has sufficient depth, 470mm (18.5"), to accommodate Isotech's largest Water Triple Point Cells providing a cost effective sub mK calibration system. There are accessories to hold Mercury, Water, Gallium and Indium ITS-90 Fixed Point Cells.

Isotech baths have always been designed for thermometer calibration, setting the standard for immersion depth versus filling costs. As the Orion requires just 8.5L of fluid it offers significant cost savings, both initial and the on going running costs, when compared to other larger volume baths.

In operation the liquid level is within 10mm of the top lid allowing calibration of liquid in glass thermometers without the need for complicated accessories.

In addition to using a monocular to aid reading the scale I-Cal Easy automatic calibration software can capture images with low cost digital webcams.

The Isotech Orion range provides many features that laboratories need but which other manufacturers often cannot supply.



- Deep immersion depth (470mm / 18.5") with low filling costs
- Variable Speed Stirring - allowing optimum performance for a wide range of liquid viscosities
- Modular design for easier maintenance
- Over and Under Temperature Protection - protect expensive Water Triple Point Cells as well as over temperature conditions
- Connections for easy drain and overflow
- Automatic Power Up - no manual intervention needed - easier automation - energy saving
- Liquid Level to suit Liquid in Glass Thermometers - no level adaptors required

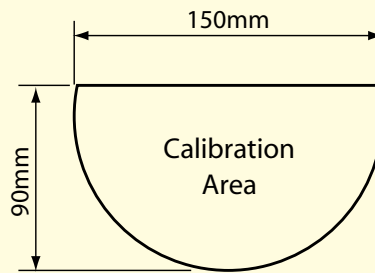
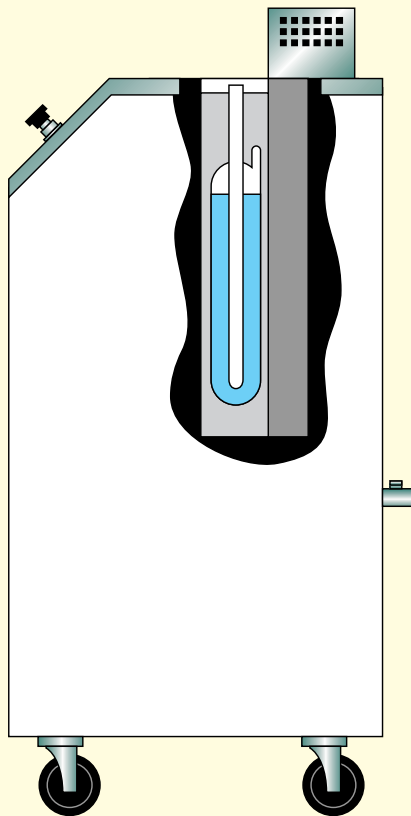

The diagram (left) shows a section view of the Orion showing its ability to house even the largest of cells

The cell shown is a Jarrett- Isotech B-11, 450mm total length and 65mm diameter.

Model	796L	796M	796H
Temp Range	-80°C - 125°C	-40°C - 125°C	30°C - 300°C
Volume	150mm Diameter, 470mm Deep (8.5 litres)		
Absolute Stability	±0.006°C (Ethanol, -80°C)	±0.006°C (Ethanol, -40°C)	±0.006°C (C10 Oil, 125°C)
Vertical Uniformity	±0.005°C (Ethanol, 0°C)	0.005°C (Ethanol, 0°C)	±0.007°C (C10 Oil, 125°C)
Heating time	25°C to 125°C < 50 mins (C10 Oil)		30°C to 300°C < 120 mins (VH Oil)
Cooling time	0°C to -80°C < 240 mins (Methanol)	10°C to -40°C < 180 mins (Methanol)	-
Communications	Includes Serial Interface, PC Cable and Software		
Dimensions	485mm wide, 525mm deep, 1150mm high		
Weight	78kg	68kg	48kg
Safety	Compliant to CE Regulations		
Power	2.8kW	1.5kW 108-130 or 208-240V, 50/60Hz	800W
How to Order	796L	796M	796H

Refer to Evaluation Report for Full Details

Accessories:

The Orion can be supplied with both copper and aluminium equalising blocks. Aluminium is recommended for use only with oils. Copper, with its better corrosion resistance, is recommended for oils, alcohol and water.

Refer to 'Liquid Selection Guide' on page 81 for information on liquids and important Health and Safety Information. The standard probe holder can support RTD's, Thermocouples and Liquid in Glass

Thermometers. A monocular is available to aid reading the scale of a L.I.G. Thermometer.

The liquid level is typically within only 10mm of the lid, so complicated fluid level adaptors are not essential.

There are a range of supports to hold various fixed point cells, Slim and Optimal, allowing the bath to realise ITS-90 fixed point cells to sub mK uncertainties.

Isotech has a full range of fixed point cells, for more details visit our web-site: www.isotech.co.uk

Accessories - Refer to 'Liquid Selection Guide' on page 81 for information on liquids and important Health and Safety Information

Lid 796-05-02 Liquid Volume Lid
Included

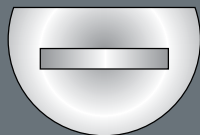

Equalizing Block 798-05-02A Aluminium Equalizing Block, 4 pockets, 8mm diameter, 160mm deep

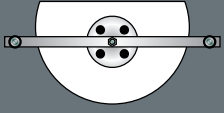

798-05-02B Copper Equalizing Block, 4 pockets, 8mm diameter, 160mm deep

798-05-02C Special Aluminium Equalizing Block *To suit customer requirements.*

798-05-02D Special Copper Equalizing Block *To suit customer requirements.*

Dual Cell Holder 796-05-01 Standard Dual Cell Holder
Includes interchangeable Cell adaptors

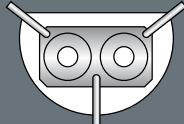

Fixed Point Cells

17724 Mercury Triple Point Cell
-38.8344°C



B12 Water Triple Point Cell
0.01°C

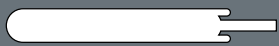

17401 Gallium Melt Point Cell
29.7646°C



17401M Slim Gallium Melt Point Cell
29.7646°C



17668ML Indium Freeze Point Cell
156.5985°C



Sensor Holder 798-05-04 Thermometer Support Kit
Holds up to 12 sensors between 3mm diameter and 8mm diameter

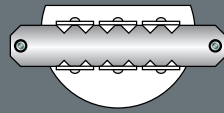

Overflow Adapter 796-02-10 The Orion liquid level is within 10mm of the top lid allowing most liquid in glass thermometers to be calibrated.



For applications where the liquid level needs to be higher than the lid the Overflow Adapter can be fitted to the Orion L and M. This assembly includes a motor to pump the liquid and raises the liquid level 20mm above the top lid.

Includes Power Supply

Monocular and Support 796-03 Monocular with x8 magnification to ease reading liquid in glass thermometers
Includes Tripod

